

Concerning Compact Discs

Only compact discs bearing this mark can be used with this unit.

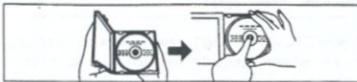

How to remove a disc from its case



How to store the disc in its case

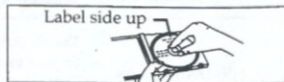

How to hold a disc

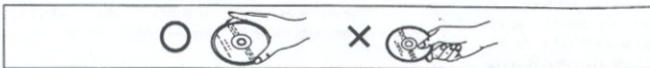

If the surface is dirty

Wipe it with a damp cloth and then wipe dry. Wipe from the center toward the outer circumference.

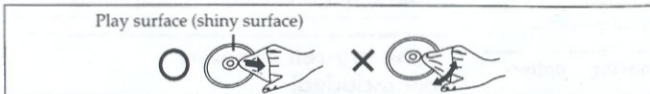

If moisture has formed on a disc

When moisture has formed because the disc was brought suddenly into a warm room from a cold environment, wipe it off using a soft dry cloth.

When storing discs

Avoid locations which are

- Exposed to direct sunlight.
- Susceptible to high levels of humidity or dust.
- Directly exposed to heat from a heating appliance.
- On top of a car dashboard or near the rear window.

Handling precautions

- On the label side (the side with writing) Do not write anything using a pencil, ball-point pen, etc. Do not stick paper or labels.
- On the disc (shiny) side Handle this side carefully to keep it free from fingerprints or scratches. Do not use record cleaners, solvents, etc.
- Do not attach labels or stickers to CD's. Do not use CDs with exposed adhesive from tape or left over peeled off stickers.
- Do not use scratch-proof protectors or covers other than those specified for use with this unit.

Panasonic Consumer Electronics Company, Division of Matsushita Electric Corporation of America

One Panasonic Way Secaucus, New Jersey 07094

Panasonic Sales Company, Division of Matsushita Electric of Puerto Rico, Inc. ("PSC")

Ave. 65 de Infernaria, Km. 9.5 San Gabriel Industrial Park, Carolina, Puerto Rico 00985

Panasonic Canada Inc.

5770 Ambler Drive, Mississauga, Ontario L4W 2T3

RQT3745-P
F1296R0

Portable CD player

Panasonic®

Dear Customer

Thank you for purchasing this product. For optimum performance and safety, please read these instructions carefully.

The model number and serial number of this product can be found on either the back or the bottom of the unit.

Please note them in the space provided below and keep for future reference.

MODEL NUMBER _____
SERIAL NUMBER _____

SL-S221C/SL-S321C/SL-S332C ONLY

To install this product in the car, please refer to the "Installation Instructions" (attached sheet).

The SL-S225 and SL-S332C models are only for U.S.A.

Operating Instructions

SL-S220/SL-S225 SL-S320/SL-S221C SL-S321C/SL-S332C



Supplied Accessories

Check the packing carton for these accessories.

AC adaptor 1 pc.

For U.S.A. and Canada (RFEA403C-S)

For others (RFEA403Z-S)

For Canada only

Stereo earphone 1 pc.

(RFEV317P-KS)

For others

Stereo headphones 1 pc.

(RFEV705P-KS)

SL-S225 ONLY

Rechargeable Ni-Cd batteries 2 pcs.

(RP-BP60PYS)

Battery carrying case 1 pc.

(RFKNL370-K)

Remove the rechargeable batteries from their case before use.

Use numbers indicated in parentheses when asking for replacement parts.
(Only for U.S.A.) To order accessories call PASC Accessory Dept. 1-800-332-5368.

SL-S221C/SL-S321C/SL-S332C ONLY

Car adaptor 1 pc.

(SH-CDC2PPY)

Car stereo cassette adaptor 1 pc.

(SH-CDM8ASY-K)

SL-S332C ONLY

Wireless remote controller 1 pc.

(RAK-SL927WH)

Battery for Wireless remote controller 1 pc.

(CR2025/1P0D)

For area except U.S.A. and Canada

Power plug adaptor 1 pc.

(SJP5213-2)

Before connecting, operating or adjusting this product, please read these instructions completely. Please save this manual.



Precautions

Before using this unit, be sure to read the applicable items of the operating instructions and these safety suggestions carefully.

Afterwards keep them handy for future reference. Take special care to follow the warnings indicated on the unit itself as well as in the operating instructions.

Safety

- 1. Power Source**—The unit should be connected to power supply only of the type described in the operating instructions or as marked on the unit. Use only the AC adaptor or car adaptor described in the operating instructions when recharging.
- 2. Polarization**—If the unit is equipped with a polarized AC power plug (a plug having one blade wider than the other), that plug will fit into the AC outlet only one way. This is a safety feature. If you are unable to insert the plug fully into the outlet, try reversing the plug. If the plug should still fail to fit, contact your electrician to replace your obsolete outlet. Do not defeat the safety purpose of the polarized plug.
- 3. Care of AC adaptor**—Take care that the cord of the AC adaptor should be routed so that they are not likely to be walked on or pinched by items placed upon or against them. Never take hold of the AC adaptor if your hand is wet, and always grasp the plug body when connecting or disconnecting it.
- 4. Nonuse Periods**—When not in use, be sure to disconnect the AC adaptor from the AC power outlet.

- 5. Batteries**—If the set is not used for a long period of time or is used only from an AC power source, remove all the batteries to prevent potential damage due to possible battery leakage. Do not mix batteries (old and new) or different types of batteries.

Installation

Environment

- 1. Water and Moisture**—Do not use this unit near water—for example, near a bathtub, washbowl, swimming pool, or the like. Damp basements should also be avoided.
- 2. Condensation**—Moisture may form on the lens in the following conditions...
 - immediately after a heater has been turned on.
 - in a steamy or very humid room.
 - when the unit is suddenly moved from a cold environment to a warm one. If moisture forms inside this unit, it may not operate properly. To correct this problem wait about one hour for the moisture to evaporate.
- 3. Heat**—Never use or place this unit near a heat source. Do not leave it in an automobile exposed to direct sunlight for a long time with the doors and windows closed as this may deform the cabinet.

Placement

- 1. Foreign Material**—Care should be taken so that objects do not fall into and liquids are not spilled into the unit. Do not subject this unit to excessive smoke, dust, mechanical vibration, or shock.
- 2. Magnetism**—The unit should be situated away from equipment or devices that generate strong magnetic fields.
- 3. Stacking**—Do not place any objects, on top of the unit.

Maintenance

(See page 7 for details.)

Clean the cabinet, panel and controls with a soft cloth lightly moistened with mild detergent solution. Do not use any type of abrasive pad, scouring powder or solvent such as alcohol or benzene.

Service

- 1. Damage Requiring Service**—The unit should be serviced by qualified service personnel when:
 - (a) The AC adaptor is damaged; or
 - (b) Objects have fallen or liquid has been spilled into the unit; or
 - (c) The unit has been exposed to rain; or
 - (d) The unit does not appear to operate normally or exhibits a marked change in performance; or
 - (e) The unit has been dropped, or the enclosure damaged.
- 2. Servicing**—The user should not attempt to service the unit beyond that described in the operating instructions. All other servicing should be referred to an authorized service personnel.
(Only for U.S.A.)
Call 1-800-545-2672 for the address of an authorized factory servicenter.

Power Supply Preparations

Refer to the specifications (page 8) for information on operating times when using rechargeable batteries or dry-cell batteries.

Using rechargeable batteries

Obtain the optional rechargeable batteries for SL-S220, SL-S320, SL-S221C, SL-S321C and SL-S332C.

Make sure to recharge the batteries before using them. The unit cannot be used to charge rechargeable batteries other than those specifically designed for it.

- Supplied batteries for SL-S225 (RP-BP60)
- Optional batteries (SH-CDB8D)

Recharging procedure

- 1 Insert the special rechargeable batteries into the unit.

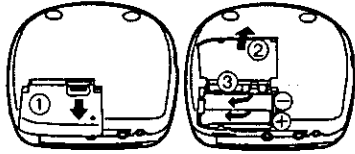

- 2 Connect the AC adaptor.

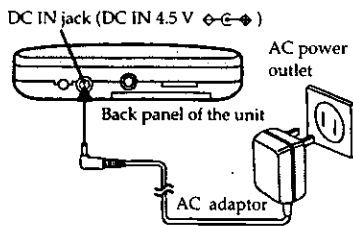

- 3 When recharging is complete, unplug the AC adaptor from the power outlet and the DC IN jack.

Notes

- It takes approximately three hours to fully recharge the rechargeable batteries.
- Rechargeable batteries have a service life of approximately 300 charge-discharge cycles. If the operating time on one full charge becomes noticeably shorter than it used to be, the battery has reached the end of its service life and should be replaced.
- You can operate the unit with the AC adaptor while recharging the batteries, but it will lengthen the recharging time.
- The AC adaptor and rechargeable batteries may become warm while recharging is in progress. This is not a malfunction.

If the battery lid comes loose

Slide the lid back into place horizontally.

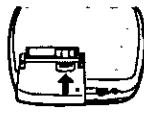

Removing batteries

Push up on the battery in the direction indicated by the arrow. Then lift it out.

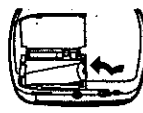

Using the AC adaptor

Connect the AC adaptor supplied.

Refer to "Using rechargeable batteries" for connection instructions.

Using the car adaptor

The SL-S221C, SL-S321C and SL-S332C come with a car adaptor. Be sure to use the adaptor specially designed for this model. (Refer to the separate installation instructions.)

Be sure to obtain the car adaptor (SH-CDC9) for SL-S220, SL-S225 and SL-S320, available as an optional accessory. The car adaptor can be used to recharge the unit's batteries while in the car.

CAUTION:

Use only car adaptor, Model: SH-CDC9 manufactured by Matsushita Electric Industrial Co., Ltd.

Using dry-cell batteries (not included)

After disconnecting the AC adaptor, insert two "AA" (LR6) alkaline batteries.

The procedure for inserting and removing dry-cell batteries is identical to that for rechargeable batteries.

Battery indicator



This indicator flashes on and off when the batteries are almost out of power. Power is cut off completely a short while later.

Rechargeable batteries: Recharge batteries.

Dry-cell batteries: Replace batteries with new ones.

Notes

- The length of time the unit will continue to operate between when the battery indicator starts flashing and when the power is cut off differs depending on the type of batteries used.
- The battery indicator may not flash if rechargeable batteries, other than those designated by Panasonic, are used.

Accidental Operation Prevention Function

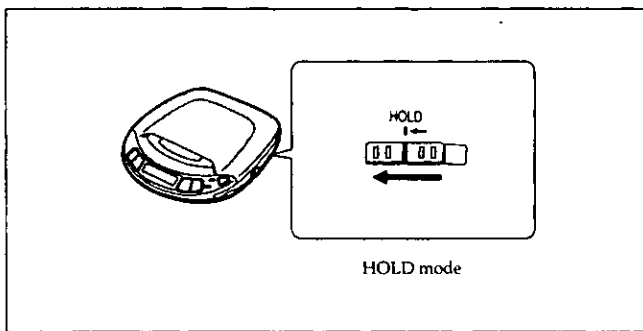

This function causes the unit to ignore short, accidental button presses. (The disc lid can still be opened and closed.)

The misoperation prevention function prevents the following:

- Powering on the unit accidentally (which can cause the batteries to go dead).
- Play being cut off unexpectedly in the middle of a selection.

To use the accidental operation prevention function

Set HOLD to the HOLD position.

"ho;d" Indication

When the unit is in hold status, pressing any operation button (other than the OPEN button) causes the indication "ho;d" to appear on the display.

When the unit is powered off

The "ho;d" indication appears only when the ►|| button is pressed.

Before operating the buttons

Be absolutely sure to move HOLD to release the unit from the hold mode.

Locations of Controls

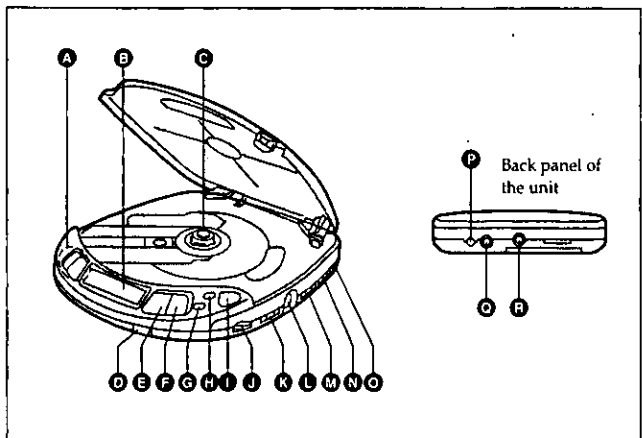

- A** Skip/search buttons (◀◀, ▶▶) • SKIP = SEARCH

- B** Display

- C** Push button (PUSH)

- D** SL-S332C ONLY

- Remote sensor (SENSOR)

- E** Play/pause button (▶||)

- F** Stop/power off button (■, POWER OFF)

- G** Memory/recall button (MEMORY/RECALL)

- H** Repeat button (REPEAT)

- I** Open button (OPEN)

- J** Headphones volume control (VOLUME)

- K** SL-S220/SL-S225/SL-S221C
SL-S320/SL-S321C

- XBS selector (XBS)

- SL-S332C

- LIVE/XBS selector

- (LIVE, XBS, OFF)

- L** Headphones jack (⊙)

- M** Play mode selector (RESUME, NORMAL, RANDOM)

- N** Hold switch (HOLD)

- O** SL-S220/SL-S225/SL-S221C

- Anti-shock switch (ANTI-SHOCK)

- SL-S320/SL-S321C/SL-S332C

- Extra anti-shock switch

- (EXTRA ANTI-SHOCK)

- P** Out jack (OUT)

- DC in jack (DC IN 4.5 V ⚡)

- Q** Hole for car insulator mounting screw

Sequential Play Basic Play

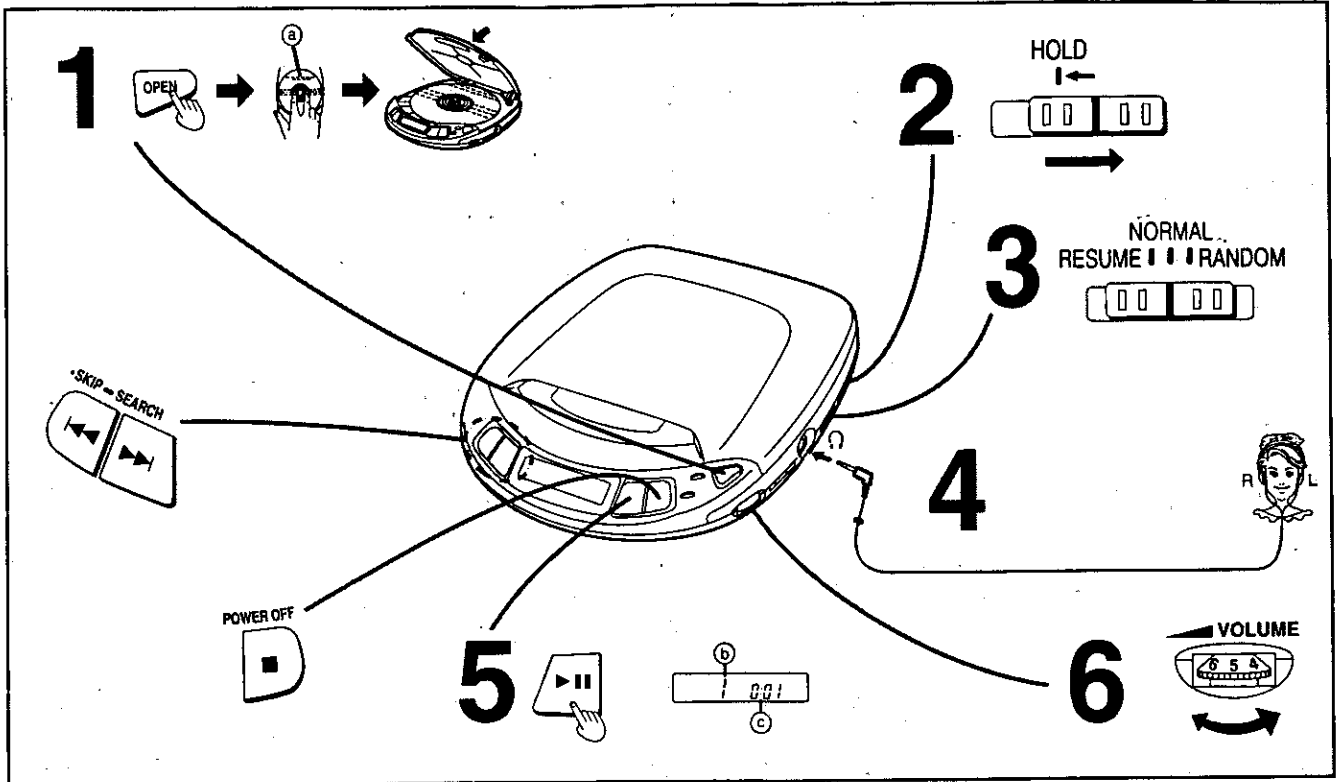

Following steps 1-6.

Ⓐ Label must face upward. Ⓑ Track number in play Ⓒ Elapsed playing time of each track
In step 4, connect the stereo headphones/earphones to the () jack. (Plug in firmly.)

• Play stops automatically when all the tracks have been played.

• If the unit has been connected to the car audio system, adjust the volume level between 4 and 6 on the unit, then adjust the volume level on the system.

For your reference:

"no disc" indication

This indication appears for about 30 seconds if the ►|| button is pressed when no disc is loaded in the unit or if the disc is not completely seated.

"OPEN" indication

This indication appears for about 10 minutes when the cover is opened. (However, the indication does not appear when the unit is powered off.)

Note

Never insert foreign objects into the unit body.

Removing discs

After the disc has stopped rotating, press the PUSH button to release the disc. (To protect the disc, never open the cover while it is playing.)

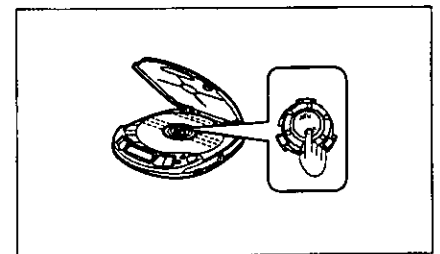

Auto power off function

If the unit is left in stop or paused status for approximately 10 minutes, the unit powers itself off automatically in order to prevent the battery from running down.

Operation	Button	Display/reference
To pause play	Press during play 	 Press again to resume play
To stop play Stop mode	Press during play 	Total number of tracks Total playing time
To turn off the unit Off mode	Press during stop mode 	
Skip forward/ backward (skip function)	Press during play 	<ul style="list-style-type: none"> • During program play, these buttons are used to skip forward or back through the programmed sequence of tracks. • During random play, the skip buttons cannot be used to skip back to tracks that were played previously in the random sequence. • During program play, random play or 1 track repeat play, search operation is limited to the current track only.
Rapid forward/ backward (search function)	(Backward) (Forward) Keep depressed during play	

SL-S221C/SL-S321C/SL-S332C

Backlight

The backlight comes on to illuminate the display panel when the unit is used with a AC adaptor or car adaptor.

Other Play Methods

The letters such as **A** in the various illustrations refer to the descriptions in the "Location of Controls" (see page 2) section.

Skip play

The disc plays from the specific track through to the end, then play stops automatically.

Preparation: Put unit in stop mode.

1

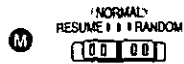

2 Select the desired track.



3



Random play

1

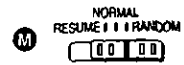

2



Release

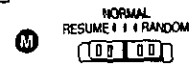

For your reference:

- It is also possible to press the **▶▶** button while the unit is in stop status to change the first track to be played. (All tracks are played eventually, regardless of which is played first.)
- Program play is not possible in the random mode.

Resume play

This function allows you to listen from the beginning of the track where play stopped because the unit was powered off (or switched to stop status). It is useful when listening to CDs in the car, etc.

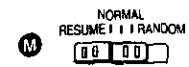

Release



For your reference:

- If the RESUME, NORMAL, RANDOM (play mode selector) slider is put in the RESUME position, the all-repeat function will be activated automatically as soon as the unit is powered on.
- If power is cut off near the end of a track (power off status), playback may resume from the beginning of the next track in some cases.
- If the unit is powered off while a disc was playing and then a new disc is inserted, play will begin from the middle of the new disc because the unit remembers the position where play stopped on the old disc.

Program play

Up to 24 tracks can be entered in the programmed sequence.

Preparation: Put unit in stop mode.

1

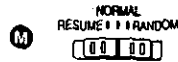

2 Select the desired track.



3 Register in sequence.

(The indication "M" and the programmed sequence appear on the display panel.)



4 Repeat steps 2 and 3 to program all the desired tracks.

5



■ To program the same track in the sequence more than once

After step 3, press MEMORY/RECALL the desired number of times.

■ If "F" is displayed

No more tracks may be added to the sequence.

■ To confirm the contents of the programmed sequence

Press MEMORY/RECALL while the disc is playing. (The number of the programmed tracks appear on the display panel in sequence.)

■ To delete the entire programmed sequence

Press **■**, POWER OFF.

Repeat function

Press REPEAT while disc is playing or when unit is in stop status.



For your reference:

If REPEAT is pressed during program play, only the tracks in the programmed sequence are repeated. (The indication "ALL" is not displayed.)

The setting is switched in the sequence indicated below each time REPEAT is pressed.

1-track repeat (1 )

One track is repeated.

All-track repeat (ALL )

All the tracks on the disc are repeated.

Cancel

Changing the sound quality

SL-S220/SL-S225/SL-S221C
SL-S320/SL-S321C

XBS ON:

Select this setting to boost the low-range response.

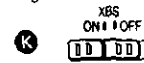

OFF:

Select this setting to turn off the XBS function.

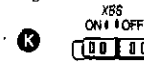

SL-S332C

XBS:

Select this setting to boost the low range response.



LIVE:

Select this setting to reproduce the sound as it would be heard in a concert hall.

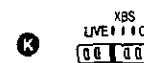

OFF:

Select this setting to turn off the XBS and LIVE functions.

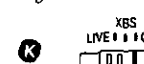

Note

This function is available except when using the OUT jack.

Anti-Shock/Extra Anti-Shock Function

SL-S220/SL-S225/SL-S221C

This function minimizes sound interruption when vibrations are encountered by utilizing audio data that has been stored ahead of time (up to approximately 3 seconds' worth).

SL-S320/SL-S321C/SL-S332C

This function minimizes sound interruption when vibrations are encountered by utilizing audio data that has been stored ahead of time (up to approximately 10 seconds' worth).

1 SL-S220/SL-S225/SL-S221C

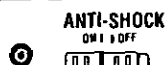



SL-S320/SL-S321C/SL-S332C



2



4

M.RESERVE indicator status	Unit body status	Play status (audio data status)
	Stable	Normal (plenty of data is stored)
	Bump encountered	Normal (stored data is used)
	Bumping stops	Normal (data again starts to be stored)
	Bumps continue repeatedly	Sound is interrupted (data buffer empty)

Notes

- The position of the ANTI-SHOCK/EXTRA ANTI-SHOCK slider can be changed during play, but this may cause a slight interruption in the sound because the disc's rotational speed changes.
- During ANTI-SHOCK/EXTRA ANTI-SHOCK operation, the disc rotates at a higher rate than usual in order to collect extra audio data. This may cause the batteries to run out faster and could result in a slight increase in disc rotation noise.

Using the unit with an audio system

The ANTI-SHOCK/EXTRA ANTI-SHOCK uses digital signal compression technology. It is recommended that the ANTI-SHOCK/EXTRA ANTI-SHOCK be kept in the OFF position if the unit is connected to a home audio system.

Using the Wireless Remote Controller SL-S332C ONLY

The wireless remote controller can be operated regardless of the hold mode of the unit.

Preparation

Installing the lithium battery

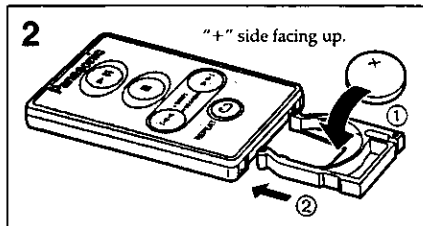
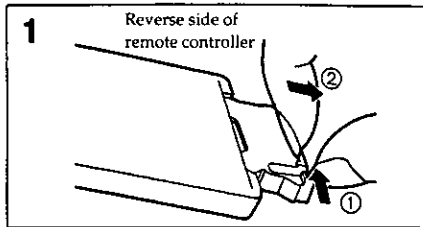

Notes

- Do not place any object which will block the path of the signals between the remote controller and the unit.
- Do not allow the remote sensor or transmitter to become dusty.
- Do not leave the remote controller standing in direct sunlight or in high temperature locations in a car.
- In the interest of traffic safety, do not operate the remote controller while driving.
- Take every care to prevent small children from putting the lithium battery in their mouths or swallowing it. In the event that a child has swallowed a battery, consult with a physician immediately.

CAUTION:

The battery used in this device may present a risk of fire or chemical burn if mistreated. Do not recharge, disassemble, heat above 100°C (212°F), or incinerate. Replace battery with Panasonic part number CR 2025/1P0D only. Use of another battery may present a risk of fire or explosion.

Dispose of used battery promptly. Keep away from children.
Do not disassemble and do not dispose of in fire.

Operation

Preparation:

When the unit is to be operated using rechargeable batteries or dry cell batteries, first press **▶ ||** on the unit and then use the remote controller. (The unit cannot be operated by the remote controller while the unit is turned off.)

	Initiates play/establishes pause mode when pressed again.
	Stops play /turns the unit off when kept depressed.
	Skip tracks (tap). Rapidly searches forward or backward during play (keep depressed).
	Repeat all track or single track.

Remote controller's operating range

- Point the transmitter on the remote controller at the remote sensor on the unit.
- Use the remote controller within a 7-meter range of the remote sensor on the unit.
(Depending on the angle of the controller, the signals may not reach the sensor.)

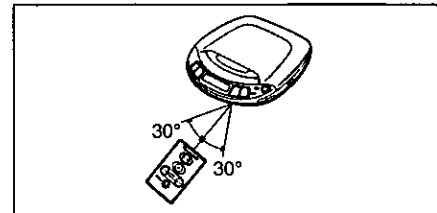

Using the Unit with Optional Accessories

Using the unit with an audio system

Using the stereo connection cable (not included), you can hear CDs on your audio system.

- Connect the cable to the amplifier after turning off its power.
- Do not connect the cable to the PHONO jacks on the amplifier.
- Obtain the optional connecting cable if the amplifier comes with mini-phone jacks.
- Adjust the volume level on the amplifier.

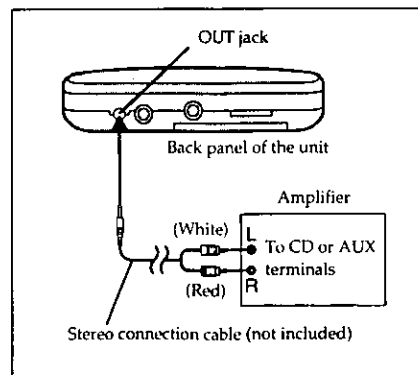

Using the unit with a car audio system stereo

The SL-S221C, SL-S321C and SL-S332C come with the car adaptor and car stereo cassette adaptor.

Items to be purchased

For connection to the car audio system:

- Car stereo cassette adaptor (SH-CDM9A)
- Connect the car stereo cassette adaptor to the unit's headphone jack.
(When doing this, keep the unit's VOLUME control at a setting between 4 and 6.)

For securing the unit and connecting the power supply:

- Car adaptor (SH-CDC9)
- Car mounting kit (SH-CDF7)
Car mounting arm, Car insulator

Note

It may not be possible to use the unit with some types of car stereo owing to restrictions imposed by the construction of the car stereo cassette adaptor.

For further details, refer to the instructions of the part concerned.

Customer Service Center 2F-3, One Panasonic Way, Secaucus, NJ 07094 (Headquarters) 201-348-9090 (9:00am-8:00pm Monday-Friday, EST)

AUTHORIZED SERVICENTERS • PARTS DISTRIBUTOR LOCATIONS

To locate an independent authorized servicer or parts distributor in your area, within the USA dial toll free 1-800-545-2672, 24 hours a day, 7 days a week.

PRODUCT REPAIRS

Factory Servicenters

CALIFORNIA
6550 Katella Avenue
Cypress, CA 90630
Phone (714) 373-7425
Fax (714) 894-8534

800 Dubuque Avenue
S. San Francisco, CA 94080
Phone (415) 871-6373
Fax (415) 871-6840

20201 Sherman Way
Suite 102
Canoga Park, CA 91306
Phone (818) 709-1775
Fax (818) 709-2165

3878 Ruffin Road
Suite A
San Diego, CA 92123
Phone (619) 560-9200
Fax (619) 560-1831

COLORADO
1640 South Abilene Suite D
Aurora, CO 80012
Phone (303) 752-2024
Fax (303) 752-0610

FLORIDA
3700 North 29th Avenue
Suite 102
Hollywood, FL 33020
Phone (954) 925-2880
Fax (954) 925-5224

4710 Eisenhower Boulevard
Suite A1
Tampa, FL 33634
Phone (813) 884-4746
Fax (813) 886-4564

GEORGIA
8655 Rosewell Road
Suite 100
Atlanta, GA 30350
Phone (770) 518-6301
Fax (770) 518-6306

HAWAII
99-859 Iwaiwa Street
Aiea, Hawaii 96701
Phone (808) 488-1996
Fax (808) 486-4369

ILLINOIS
•1703 North Randall Road
Elgin, IL 60123
12:30 to 4:30, Mon-Fri
Phone (847) 468-5464
Fax (847) 468-5465

9060 Golf Road
Niles, IL 60714
Phone (847) 608-1010
Fax (847) 299-1710

MARYLAND
Sulphur Springs
Business Park
1638 Sulphur Springs Road
Baltimore, MD 21227
Phone (410) 242-2607
Fax (410) 247-3047

MASSACHUSETTS
60 Glacier Drive, Suite C
Westwood, MA 02090
Phone (617) 329-4280
Fax (617) 329-0586

* pick-up/drop-off only

MICHIGAN
37048 Van Dyke Avenue
Sterling Heights, MI 48312
Phone (810) 939-2060
Fax (810) 939-2638

MINNESOTA
7850-12th Avenue South
Airport Business Center
Bloomington, MN 55425
Phone (612) 854-8624
Fax (612) 854-2089

OHIO
2236 Waycross Road
Cincinnati, OH 45240
Phone (513) 851-4180
Fax (513) 851-8443

PENNSYLVANIA
2221 Cabot Boulevard West
Suite B
Langhorne, PA 19047
Phone (215) 741-0661
Fax (215) 741-0521

Chartiers Valley Shopping Center
1025 Washington Pike
Bridgeville, PA 15017
Phone (412) 257-4522
Fax (412) 257-4650

TENNESSEE
919-8th Avenue South
Nashville, TN 37203
Phone (615) 244-4434
Fax (615) 244-6713

TEXAS
7482 Harwin Drive
Houston, TX 77036
Phone (713) 781-1528
Fax (713) 781-0643

13615 Welch Road
Suite 101
Farmers Branch, TX 75244
Phone (214) 385-1975
Fax (214) 960-7626

WASHINGTON
20425-84th Avenue South
Kent, WA 98032
Phone (206) 872-7922
Fax (206) 872-0918

Service in Puerto Rico

Matsushita Electric
of Puerto Rico, Inc.
Panasonic Sales Company/
Factory Servicenter
Ave. 65 de Infanteria, Km. 9.5
San Gabriel Industrial Park
Carolina, Puerto Rico 00985
Phone (809) 750-4300
Fax (809) 768-2910

REPAIR INQUIRIES

Regional Customer Care Department

EAST (PCE)
2221 Cabot Boulevard West
Suite A
Langhorne, PA 19047
Phone (215) 741-0676
Fax (215) 750-6492

Covers:
CT, DE, ME, MD, MA,
NH, NJ, NY, PA, RI, VT,
VA, DC, WV

EAST (PCE)
1225 Northbrook parkway
Suite 2-390
Suwanee, GA 30174
Phone (404) 338-6860
Fax (404) 338-6348

Covers:
AL, FL, GA,
MS, NC, SC, TN

CENTRAL (PCC)
1707 North Randall Road
Elgin, IL 60123
Phone (847) 468-5530
Fax (847) 468-6528

Covers:
AR, IL, IN, IA, KS, KY,
LA, MI, MN, MO, NE,
ND, OK, SD, TX, WI, OH

WEST (PCW)
6550 Katella Avenue
Cypress, CA 90630
Phone (714) 373-7440
Fax (714) 373-7447

Covers:
AK, AZ, CA, CO, ID,
MT, NV, NM, OR, UT,
WA, WY, HI

ACCESSORY PURCHASES

1-800-332-5368 (Consumer Orders Only) Panasonic Services Company 20421 84th Avenue South Kent, WA 98032
(6 am to 6 pm Monday-Friday; 6 am to 10:30 am Saturday; PST) (Visa, Mastercard, Discover card, American Express, Check)

PANASONIC CONSUMER ELECTRONICS
COMPANY, DIVISION OF MATSUSHITA
ELECTRIC CORPORATION OF AMERICA
One Panasonic Way Secaucus
New Jersey 07094

PANASONIC SALES COMPANY, DIVISION
OF MATSUSHITA ELECTRIC
OF PUERTO RICO, INC. ("PSC")
Ave. 65 de Infanteria, Km. 9.5
San Gabriel Industrial Park
Carolina, Puerto Rico 00985
Tel. (809) 750-4300
FAX (809) 768-2910

PANASONIC AUDIO PRODUCTS
Limited Warranty

Panasonic Consumer Electronics Company or Panasonic Sales Company (collectively referred to as "The warrantor") will repair this product with new or refurbished parts, free of charge, in the U.S.A. or Puerto Rico from the date of original purchase in the event of a defect in materials or workmanship as follows:

AUDIO COMPONENTS, RADIOS, COMPACT DISC PLAYERS, VIDEO CD PLAYERS AND HOME ENTERTAINMENT SYSTEMS—For one (1) year.

ACCESSORIES, HEADPHONES AND CARTRIDGES—(when applicable) For ninety (90) days.

BATTERIES—(when applicable)—New rechargeable batteries in exchange for defective rechargeable batteries—For ten (10) days. Non-rechargeable batteries are not warranted.

RECHARGEABLE BATTERY PACKS—(when applicable)—New rechargeable battery packs in exchange for defective rechargeable battery packs for (90) days. Non-rechargeable battery packs are not warranted.

Carry-in or mail-in service in the continental U.S.A. can be obtained during the warranty period from a Panasonic Services Company (PASC) Factory Servicenter listed in the Servicenter Directory. Or call 1-800-545-2672, toll free, to locate an authorized PASC Servicenter. Carry-in or mail-in service in Puerto Rico can be obtained during the warranty period by calling the telephone numbers listed in the Servicenter Directory.

This warranty is extended only to the original purchaser. A purchase receipt or other proof of date of original purchase will be required before warranty service is rendered.

This warranty only covers failures due to defects in materials or workmanship

which occur during normal use and does not cover normal wear to the stylus (when applicable) or dealer installed cartridge or stylus. It does not cover damage which occurs in shipment or failures which are caused by products not supplied by the warrantor or failures which result from accident, misuse, abuse, neglect, mishandling, misapplication, faulty installation, set-up adjustment, improper maintenance, alteration, improper antenna, inadequate signal pick-up, maladjustment of consumer controls, modification, or commercial use of product, or service by anyone other than a PASC Factory Servicenter or authorized PASC Servicenter, or damage that is attributable to acts of God.

LIMITS AND EXCLUSIONS

There are no express warranties except as listed above.

THE WARRANTOR SHALL NOT BE LIABLE FOR INCIDENTAL OR CONSEQUENTIAL DAMAGES RESULTING FROM THE USE OF THIS PRODUCT, OR ARISING OUT OF ANY BREACH OF THIS WARRANTY, INCLUDING WITHOUT LIMITATION, DAMAGE TO TAPES RECORDS OR DISCS. ALL EXPRESS AND IMPLIED WARRANTIES INCLUDING THE WARRANTIES OF MERCHANTABILITY AND FITNESS FOR A PARTICULAR PURPOSE, ARE LIMITED TO THE APPLICABLE WARRANTY PERIOD SET FORTH ABOVE. Some states do not allow the exclusion or limitation of incidental or consequential damages, or limitations on how long an implied warranty lasts, so the above exclusions or limitations may not apply to you.

This warranty gives you specific legal rights and you may also have other rights which vary from state to state.

If a problem with this product develops during or after the warranty period, you may contact your dealer or Servicenter. If the problem is not handled to your satisfaction, then write to the Consumer Affairs Division at the company address indicated above.

Product Service

Do not attempt to remove the cover(s) or repair the unit yourself. Refer servicing to qualified personnel only.

Product information

For product service, product information or assistance with product operation, refer to the servicenter directory.

User memo:

DATE OF PURCHASE _____
DEALER NAME _____
DEALER ADDRESS _____
TELEPHONE NUMBER _____

Maintaining the Lens

Open the lid and clean the lens as shown in the figure. Use a cotton swab to gently wipe off any finger-prints. Recommended product: Lens cleaner kit (SZZP1038C)

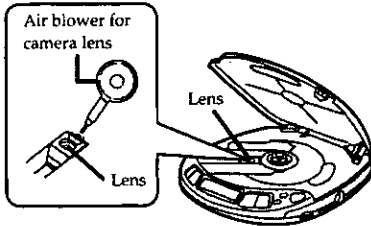

WARNING:

TO REDUCE THE RISK OF FIRE, ELECTRIC SHOCK OR PRODUCT DAMAGE, DO NOT EXPOSE THIS APPLIANCE TO RAIN, SPLASHING, DRIPPING OR MOISTURE.

CAUTION!

THIS PRODUCT UTILIZES A LASER. USE OF CONTROLS OR ADJUSTMENTS OR PERFORMANCE OF PROCEDURES OTHER THAN THOSE SPECIFIED HEREIN MAY RESULT IN HAZARDOUS RADIATION EXPOSURE. DO NOT OPEN COVERS AND DO NOT REPAIR YOURSELF. REFER SERVICING TO QUALIFIED PERSONNEL.

THE FOLLOWING PHRASES ARE APPLIED ONLY FOR U.S.A.:

POWERED BY NICKEL-CADMIUM BATTERY. MUST BE RECYCLED OR DISPOSED OF PROPERLY.

ATTENTION:

The product that you have purchased is powered by a rechargeable battery. The battery is recyclable. At the end of its useful life, under various state and local laws, it may be illegal to dispose of this battery into the municipal waste stream. Check with your local solid waste officials for details in your area for recycling options or proper disposal.



This device complies with Part 15 of the FCC Rules. Operation is subject to the following two conditions: (1) This device may not cause harmful interference, and (2) this device must accept any interference received, including interference that may cause undesired operation.

CAUTION:

This equipment has been tested and found to comply with the limits for a Class B digital device, pursuant to Part 15 of the FCC Rules.

These limits are designed to provide reasonable protection against harmful interference in a residential installation. This equipment generates, uses and can radiate radio frequency energy and, if not installed and used in accordance with the instructions, may cause harmful interference to radio communications. However, there is no guarantee that interference will not occur in a particular installation. If this equipment does cause harmful interference to radio or television reception, which can be determined by turning the equipment off and on, the user is encouraged to try to correct the interference by one of the following measures:

- Reorient or relocate the receiving antenna.
- Increase the separation between the equipment and receiver.
- Connect the equipment into an outlet on a circuit different from that to which the receiver is connected.
- Consult the dealer or an experienced radio/TV technician for help.

Any unauthorized changes or modifications to this equipment would void the user's authority to operate this device.

For
your
protection

Complete and immediately mail the Product Analysis Card so that we may contact you directly in the event a safety notification is issued in accordance with the 1972 Consumer Product Safety Act, or for other reasons Panasonic may deem necessary. Also, we ask that you complete the questionnaire so we may analyze your comments and, in this way, help us evaluate customer needs.

If you ship the product

Carefully pack and send it prepaid, adequately insured and preferably in the original carton. Attach a postage-affixed letter, detailing the complaint, to the outside of the carton.

Do NOT send the product to the Executive or Regional Sales offices. They are NOT equipped to make repairs.

Customer's Record

Model No. _____ Dealer's Name _____
Serial No. _____
or _____
Code No. _____ Dealer's Address _____
Date of Purchase _____

Specifications

Audio
 No. of channels: 2 (left and right, stereo)
 Frequency response: 20 to 20,000 Hz (+0.5 dB, -1.5 dB)
 Output voltage: 0.6 V (50 kΩ)
 S/N: More than 94 dB*
 Wow and flutter: Below measurable limit
 DA converter: 1 bit, MASH
 Headphones output level: Max. 9 mW+9 mW/16Ω (variable)

Pickup
 Light source: Semiconductor laser
 Wavelength: 780 nm

General
 Operational temperature range: 0°C-40°C (32°F-104°F)
 Rechargeable temperature range: 5°C-40°C (41°F-104°F)
 Power supply: DC 4.5 V
 Power consumption:

Power source	Anti-shock/Extra anti-shock OFF/ON
Using AC adaptor	4.3 W/4.5 W

Power consumption when recharging: 1.8 W

Play time:
 [When used in hold mode, at 25°C (77°F) temperature and on flat and stable surface]

Batteries used	Anti-shock/Extra anti-shock OFF/ON
2 alkaline batteries	About 10 h/8.5 h SL-332C ONLY About 9.5 h/8.5 h
Rechargeable batteries	About 3.0 h/2.5 h

The play time may be less depending on the operating conditions.

Recharging time: About 3 hours
 Dimension (W×H×D): 128×28.0×144 mm (5 1/4"×1 1/8"×5 1/4")
 265 g (9.4 oz) (with batteries)
 220 g (7.8 oz) (without batteries)

*These specifications were measured in the anti-shock/extra anti-shock OFF mode.

Note:
 Specifications are subject to change without notice.

Weight and dimensions are approximate.

MASH is a trademark of NTT.

Troubleshooting Guide

Before requesting service for this unit, check the chart below for a possible cause of the problem you are experiencing. Some simple checks or a minor adjustment on your part may eliminate the problem and restore proper operation. If you are in doubt about some of the check points, or if the remedies indicated in the chart do not solve the problem, refer to the directory of Authorized Service Centers (enclosed with this unit) to locate a convenient service center, or consult your dealer for instructions. (In U.S.A. consult PASC Authorized Servicenters for detailed instructions or call 1-800-545-2672 for the address of an authorized factory servicenter.)

Problem	Check this
Cannot close cover.	Is the disc properly secured in place?
Cannot play discs.	<ul style="list-style-type: none"> Is the unit in hold status? Is the disc properly secured in place? Is there moisture condensation on the lens? (Wait for about an hour and then try again.)
Cannot remove disc.	Did you press the PUSH button to release the disc?
Tracks on disc do not play in order, starting with the first track.	Is the RESUME, NORMAL, RANDOM (play mode selector) slider in the NORMAL position?
Cannot hear music—too noisy.	<ul style="list-style-type: none"> Is the headphones/earphones plug inserted all the way? Is the plug dirty? (Wipe away dirt on plug.)
TV picture is distorted. Radio reception is noisy.	Are you using the unit body too near a TV or tuner? (If the TV or tuner is connected to a simple indoor antenna, connect it to an outdoor antenna.)
SL-332C ONLY No operation with wireless remote controller	<ul style="list-style-type: none"> Is the unit turned off while rechargeable batteries or dry cell batteries are being used to operate the unit? Press ► II on unit and then proceed with operation. Has lithium battery been inserted? If it has, is its voltage level low?

Cautions

Listening caution



Do not play your headphones or earphones at a high volume. Hearing experts advise against continuous extended play.

If you experience a ringing in your ears, reduce volume or discontinue use.

Do not use while operating a motorized vehicle. It may create a traffic hazard and is illegal in many areas.

You should use extreme caution or temporarily discontinue use in potentially hazardous situations.

Even if your headphones or earphones is an open-air type designed to let you hear outside sounds, don't turn up the volume so high that you can't hear what's around you.

Sound can be deceiving. Over time your hearing "comfort level" adapts to higher volumes of sound. So what sounds "normal" can actually be loud and harmful to your hearing.

Guard against this by setting your equipment at a safe level BEFORE your hearing adapts.

To establish a safe level:

- Start your volume control at a low setting.
- Slowly increase the sound until you can hear it comfortably and clearly, and without distortion.

Once you have established a comfortable sound level:

- Set the dial and leave it there.

Rechargeable batteries

- Only the RP-BP60/SH-CDB8D batteries can be recharged.
- If the power delivered by the batteries lasts for a very short time after recharging, it means that the batteries' service life is over. Do not use them any more.
- Recharging already charged batteries will shorten their service life.
- When recharging batteries for the first time or when they have not been used for a long period of time, the play time may be shorter than usual. In a case like this, repeatedly recharge and discharge the batteries. This will restore them to their regular state.
- Do not allow any metal objects to touch the terminals of rechargeable batteries since this may cause short-circuiting which is dangerous.
- Do not peel off the plastic covering on the rechargeable batteries. Short-circuiting may occur which is dangerous.

Dry cell batteries/rechargeable batteries

To prevent damage to the batteries and electrolyte leakage, heed the following points.

- Align the ⊕ and ⊖ polarities properly when inserting the batteries.
- Do not mix different types or makes of batteries or old and new batteries.
- Remove the batteries if you do not plan to use the unit for a long period of time.
- Do not throw batteries into a fire, and do not short-circuit, disassemble or subject them to excessive heat.
- Do not attempt to recharge dry cell batteries.

Carrying dry cell batteries/rechargeable batteries around

When putting dry cell or rechargeable batteries in a pocket or bag, ensure that no other metal objects such as a necklace are placed together with them. Contact with metal may cause short-circuiting which, in turn, may cause a fire. Be absolutely sure to carry the rechargeable batteries in the battery carrying case.

When purchasing rechargeable batteries

As a safety precaution, the portable CD players made by Panasonic have a construction designed to make it impossible to recharge ordinary batteries.

To use rechargeable batteries, be absolutely sure to purchase the rechargeable Ni-Cd batteries designed especially for this unit.

Special rechargeable Ni-Cd batteries:
SH-CDB8D (set of 2)

For details, check with your dealer.

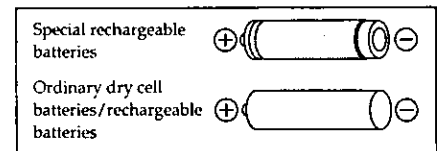

When driving a car

In the interest of traffic safety, do not operate the unit while driving.